

G-8034-C2E1-T

Adley Series

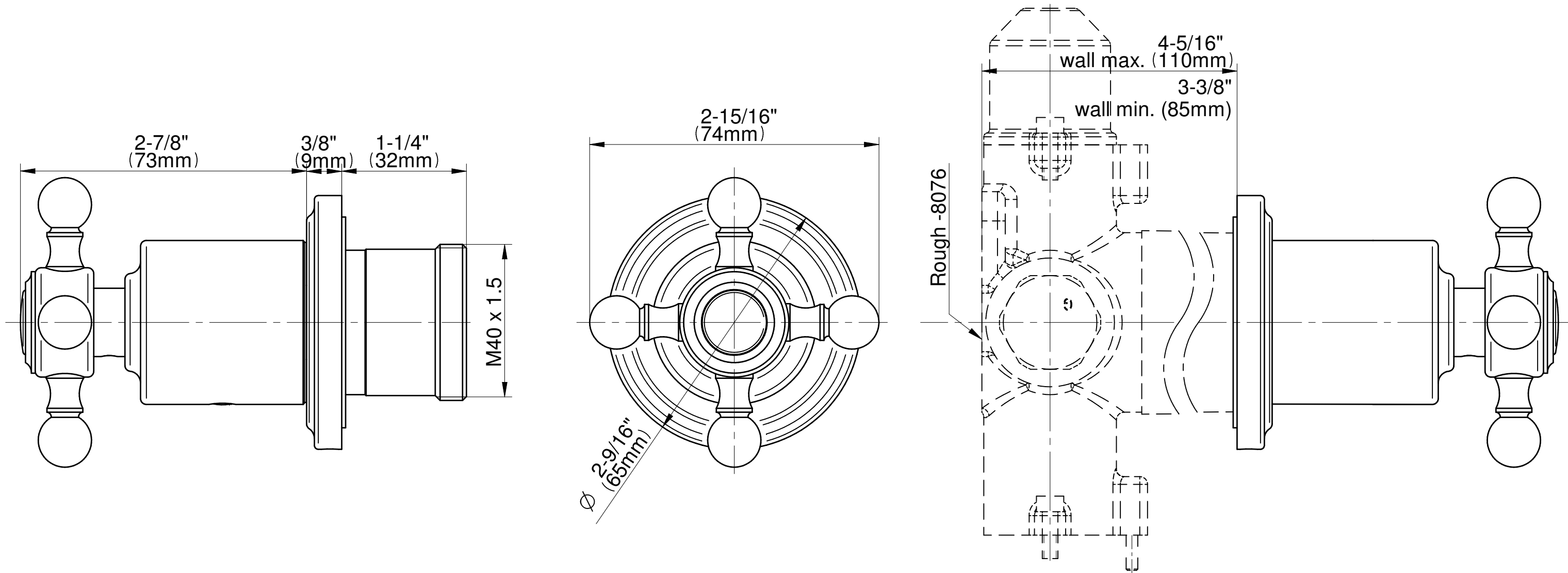

GRAFF®