

G-8079H-1L3C-T

Finezza Uno Series

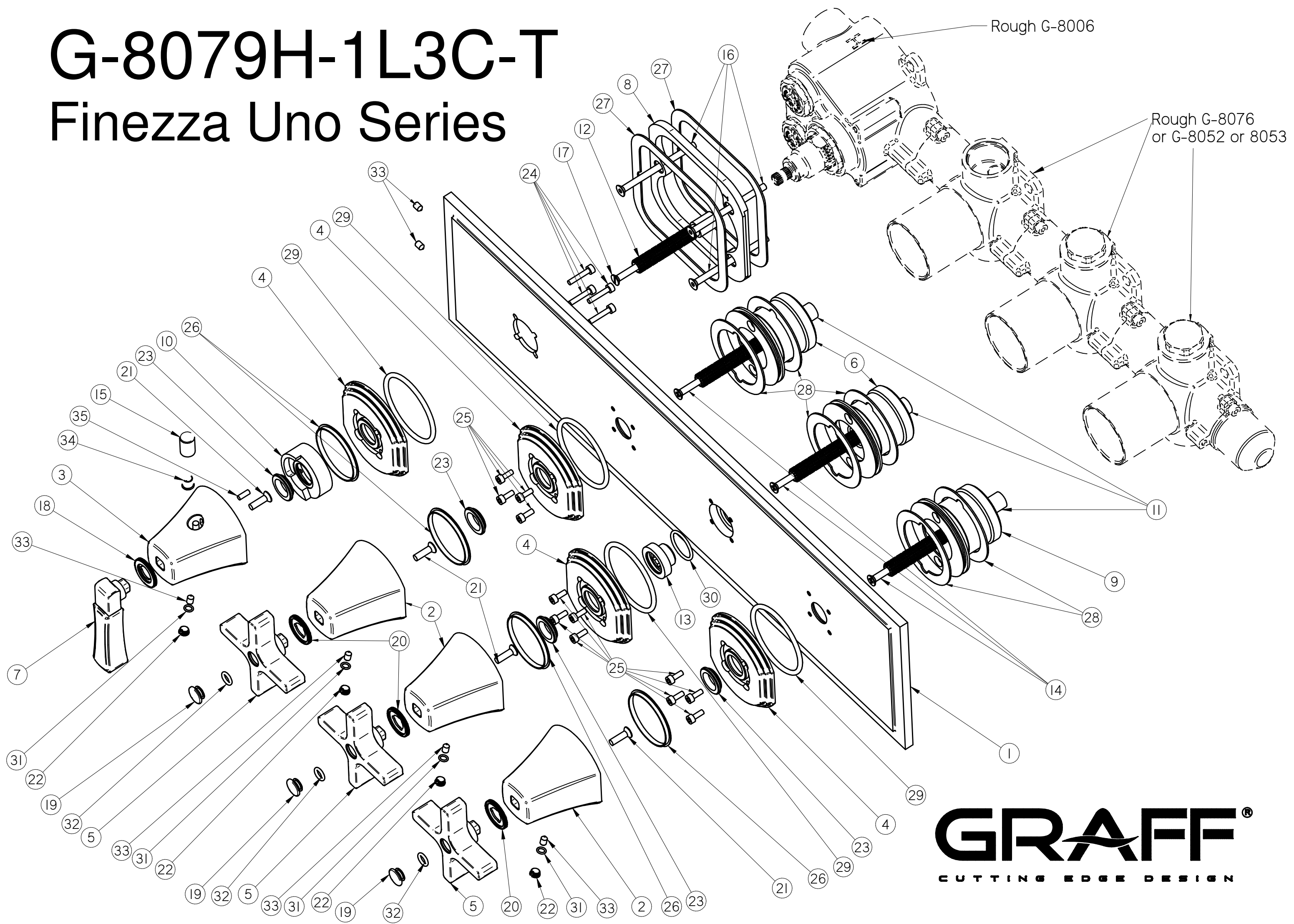

GRAFF[®]
CUTTING EDGE DESIGN