

G-8059H-LM23E0 Series

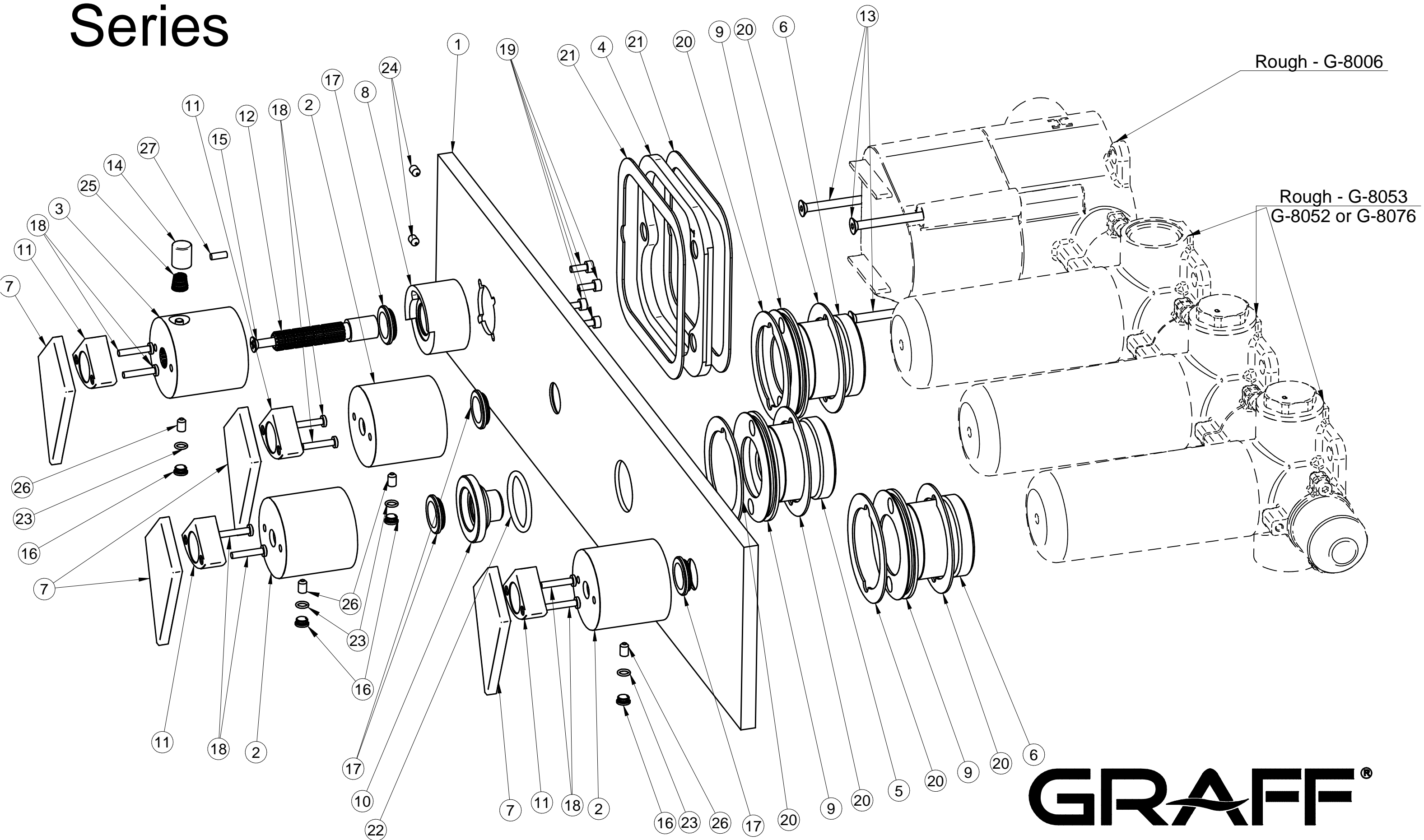

GRAFF[®]
CUTTING EDGE DESIGN