

G-8048-LM23E0 Series

Rough -G-8076 or G-8052 or G-8053

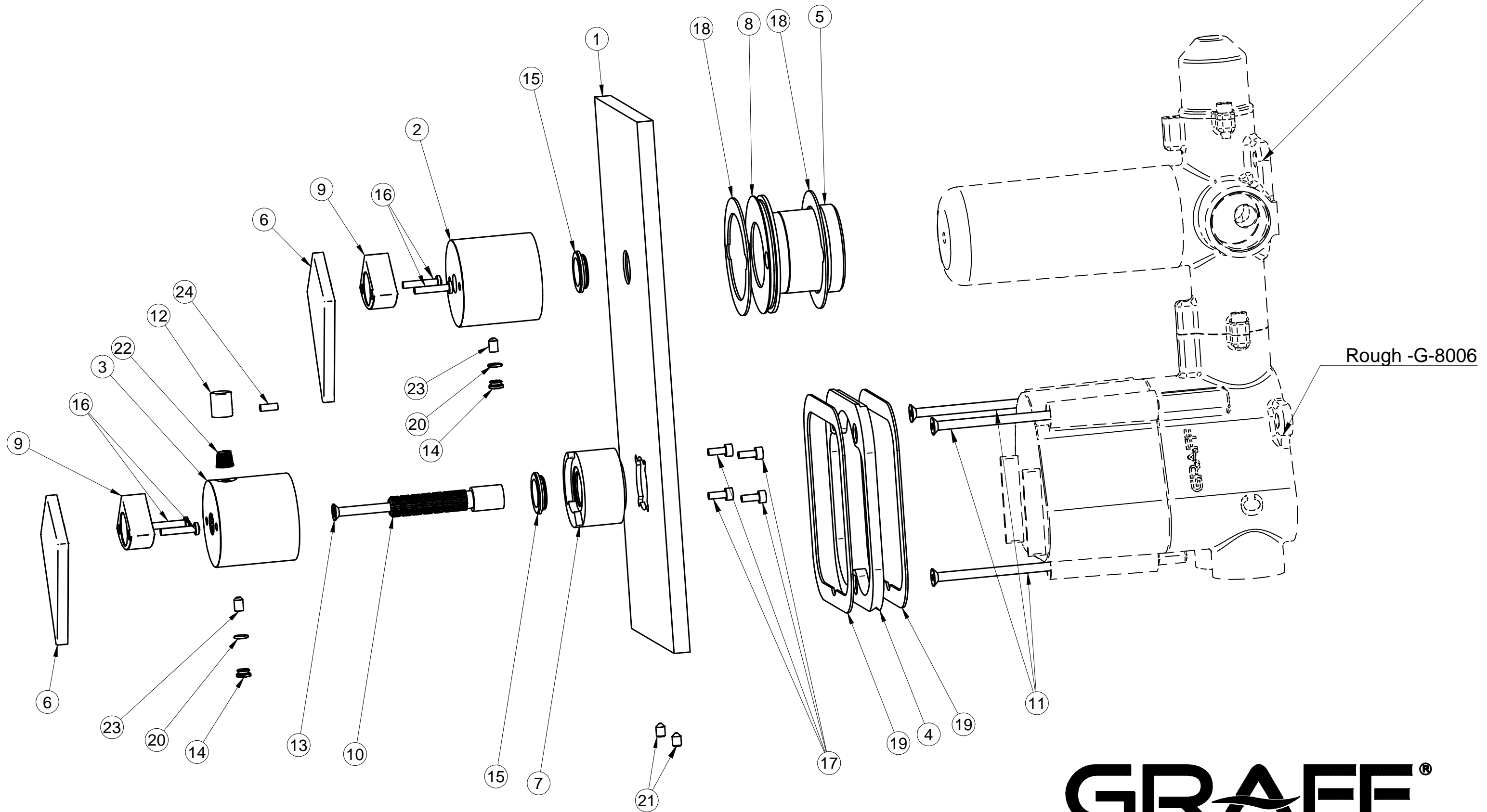

Rough -G-8006

GRAFF[®]
CUTTING EDGE DESIGN