

# 5194700

## FINEZZA DUE Series

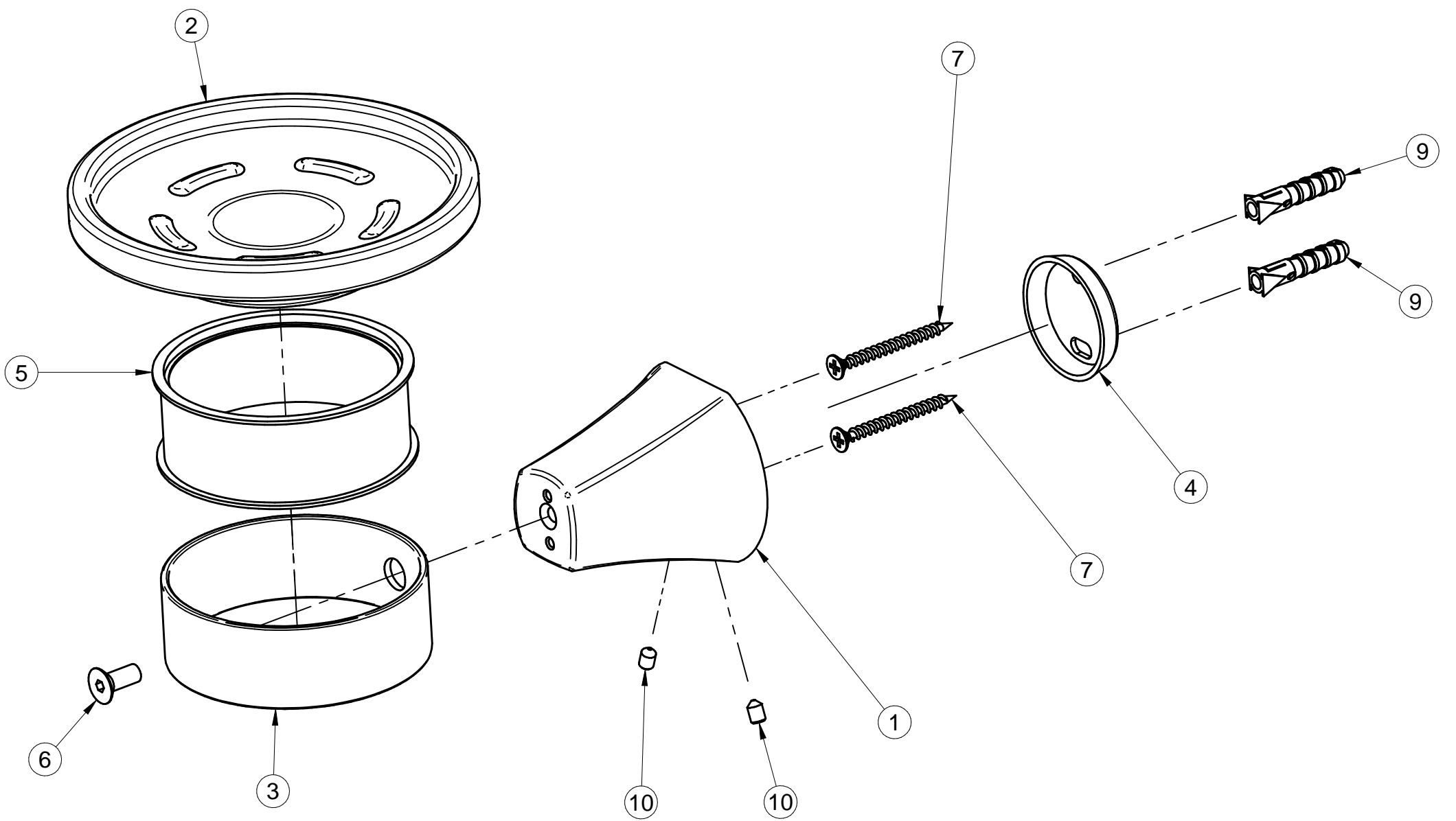

SOLID EDGE RESELLER COPY

**GRAFF**<sup>®</sup>  
CUTTING EDGE DESIGN